



Hidden Fence Brand

OWNER INSTRUCTIONS



BASIC 1200FMD HIDDEN FENCE

© 1990-2024 DogWatch Inc. All rights reserved. No photographs, illustrations or text can be reproduced in any form without the express written consent of DogWatch Inc.
© 2002-2024 Hidden Fence. All rights reserved. No photographs, illustrations or text can be reproduced in any form without the express written consent of Canine Containment Company Pty Ltd.

DogWatch, DogWatch logos, FastRead™, Automemory™, Satelek™, Performance™, Scoot™, PowerPak™, Pet-Friendly™, are all registered trademarks of DogWatch, Inc. Dog Fence,
© 2002-2024 Hidden Fence brand experts in pet containment guaranteed is a registered logo trademark. © 2010-2024 Dog Stop by Hidden Fence brand is a registered logo trademark of Hidden
fence brand. © 2002-2024 Canine Containment Company Pty Ltd. All rights reserved. DogWatch Hidden Fence Systems, The Hidden Fence Company and The Hidden Fence Company logos are
all Registered trademarks of the Canine Containment Company Pty Ltd. © 2002-2021 Boundaries plus is a registered trademark of Canine Containment Company Pty Ltd. All rights reserved

Thank You

for purchasing the DogWatch Hidden Fence system. We believe that when you purchase a quality system like the DogWatch brand, you're receiving the best system available and an investment for your pets safety. Our products and training tools promote a lifestyle of protection, and security that no other brand can offer.

If you have any questions about our products or training your pet, please contact your retailer for immediate service.

Important Safeguards

DogWatch Hidden Fence recommends that the receiver collar be removed for **at least several hours per day** to ensure no pressure sores (pressure necrosis) will develop on your pet's skin. Pressure sores may develop by having the collar on "too tight, for too long". Longer furred pets can have a slightly greater chance of sores developing, especially after swimming or being soaked with water. If sores are evident, remove the collar and wash the skin with a Dettol type of cleanser and allow to dry out and heal. Pressure sores happen to .05% of most pets.

Please read all the literature included with your DogWatch® Hidden Fence before turning the system on or beginning conditioning protocols.

- ***Do not attempt to shortcut the training of your dog.***
- ***The Hidden Fence is intended only for the purpose of containing domestic dogs and cats. Use for any other purpose is at the system owner's risk.***
- ***In the event your system requires servicing, please contact your local authorized Hidden Fence Dealer. Servicing the Dogwatch hidden fence system without using an authorized dealer may invalidate the warranty.***
- ***The Hidden Fence is recommended for dogs six (6) months or older. Your Dealer will recommend if a puppy under 6 months old is ready.***
- ***Keep the collar and the transmitter out of the reach of children.***
- ***Never adjust the transmitter or receiver when your dog is wearing the collar.***
- ***This product is only intended for use with well behaved domestic dogs. If your dog is aggressive or violent and could cause harm to itself or others within or outside the fenced premises, you should take other measures to restrain your dog.***

For additional information or help, please contact your vendor or local dealer

Many of these steps will help keep your pet safe and comfortable. The reason for these various steps is to ensure you get the best possible results "safely" from your new Hidden Fence.

- ***The Receiver Collar should not be on your dog when the system is tested. Your pet may receive an unintended correction.***
- ***The Boundary Width of the system must be tested whenever an adjustment is made to the containment field to prevent unintended corrections to your pet.***
- ***If you use a collar and leash for training, be sure the extra collar does not put pressure on the contact points.***
- ***Use care when mowing or trimming your grass not to cut the loop wire.***

MAIN COMPONENTS



FM Digital Transmitter



Receiver Collar Components (R9 shown)



Surge Protector
(OPTIONAL)



Power Supply
w/ female connector
*(may look different to
above photo)*



Flags



Zip Cord



2-Way Connector
(OPTIONAL)



MultiTool

*Items not shown (mounting hardware, joiners and cable)

Additional Tools or installation aids:

- **Additional wire and flags (if required)**
- **Drill & mounting hardware**
- **Shovel or lawn edger**
- **Wire stripping pliers**
- **Electrical tape**
- **Silicone gap sealer**
- **PVC pipe or water hose**
- **Circular saw with masonry blade**
- **Staple gun**

INSTALLATION

A hidden fence is an electronic dog fence system which has a cable that follows the perimeter of the boundary. Through the cable is a radio signal transmitted via a transmitter control unit. Your dog wears a receiver collar that receives the signal and activates a warning sound indicating proximity to the boundary. If your dog ignores the warning sound and proceeds to cross, then the dog receives a harmless electrical stimulation, influencing him to stay.

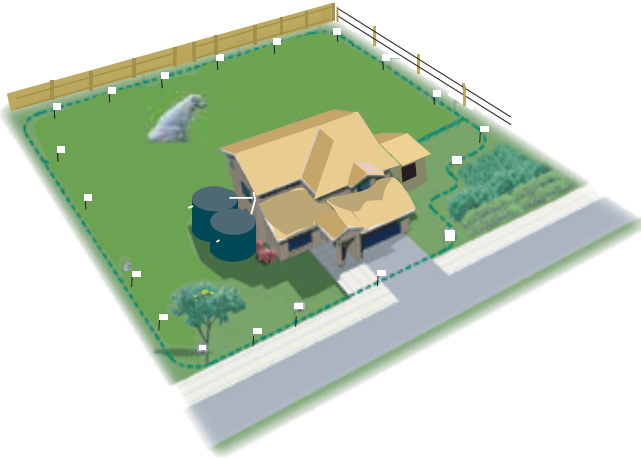

Boundary Wire: The boundary wire carries the coded FM radio signal around the perimeter of your property. Boundary cable can be placed:

- In the ground (between 50 to 150mm is ideal)
- On a fence (lower placement for digging dogs, higher for climbing dogs)
- On the ground. (use turf pegs)

Continuous Loop: In order for the system to work properly, the boundary wire must form a continuous loop. Any break in the wire will cancel the signal field. If the boundary wire is broken, the green light will go out and an audible warning will sound. Most breaks are caused by lawn/garden equipment and occasionally livestock. Technically, the better and more detailed the initial installation of the wire, the less likely a wire break will occur.

A large part of the success of the Hidden Fence is proper configuration. Cable should be installed so that it is logical for the pet to understand its boundaries without confusion. Running the cable along existing boundary fences is always the most logical for the dog to understand.

When installing additional exclusion areas, wait a week or two, so the pet can adapt to the system without confusion. Creating too many individual loops and avoidance areas may confuse your pet and make it much harder for your pet to adapt to the system.

HOW IT WORKS

COLLAR ACTIVATION DISTANCE

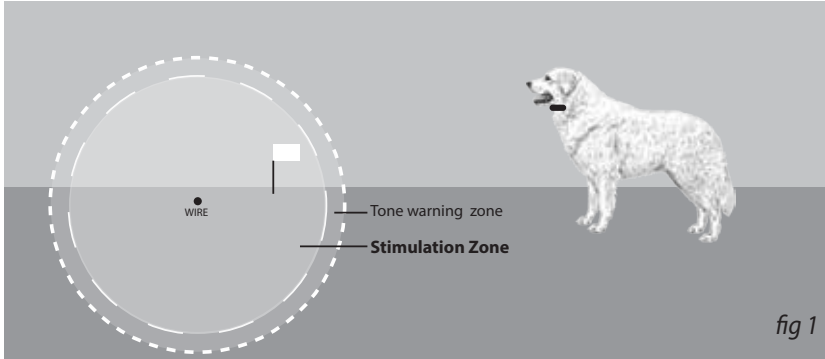

- The receiver collar activation zone is consistent around the entire cable.
(EXAMPLE: if you have a 1 metre signal range, then it'll be 1 metre high, deep, and side to side.)
- The activation distance has two zones; a TONE warning zone, and a STIMULATION zone. *fig 1*
- The TONE zone is 15% of the total activation zone emitting from the cable. *fig 1*
(EXAMPLE: if you have a 1 metre signal range, then the TONE zone is 150mm)

Most installs work well with the collar activating “around” 1 meter from the wire; BUT this is all subjective to the application.

On smaller properties that have existing fences, in many cases, the signal can be shorter.

(EXAMPLE: If you're only trying to stop a dog from scratching or digging under your fence, and you only need to stop that particular behaviour, then a collar activation distance of 400mm may be the best distance. Again, this is subjective to the application.)

ADJUSTING THE ACTIVATION DISTANCE

RANGE DISTANCE: The receiver collar activation distance is adjusted by the **Range dial** on the side of the Transmitter.

This dial is responsible for where you want your dogs collar to activate.

Use your finger tip, or a screwdriver and “GENTLY” turn the dial clockwise until you get the desired collar activation distance.
DO NOT OVER TURN THE DIAL.



Designing your fence

Boundary Configuration Examples

Proper configuration is key to a pet's success on a system. This cannot be ignored as the boundary area where the pet is going to be "corrected" if attempting to pass, makes sense.

Please study these various options as boundary possibilities.

Traditional

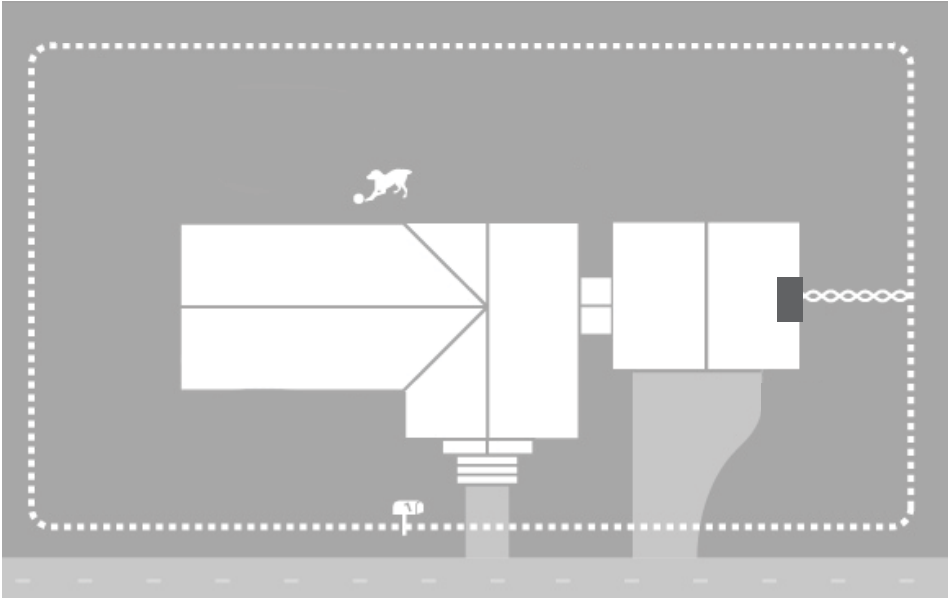

**Simple and Recommended boundary configuration.
Covers entire boundary and offers full protection.**

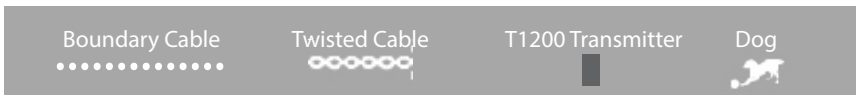

- Cable can be attached to a fence, or buried in the ground. If burying, we recommend 50mm minimum depth. If burying in a gravel driveway or under a gate, put the cable through garden hose or PVC pipe to protect it from heavy sources.
- The T1200 Transmitter is NOT waterproof. The transmitter and AC adaptor must be under cover or protected from water or rain.
- If driveway is concrete, try and use an existing expansion joint in the concrete to place your wire. Use a silicon sealer to seal the cable in place.
If asphalt driveway, make a 4mm wide x 5mm deep groove using a circular saw. Place wire in the groove and use a black silicon sealer to hold in place

Designing your fence

Back Yard only, with front protection

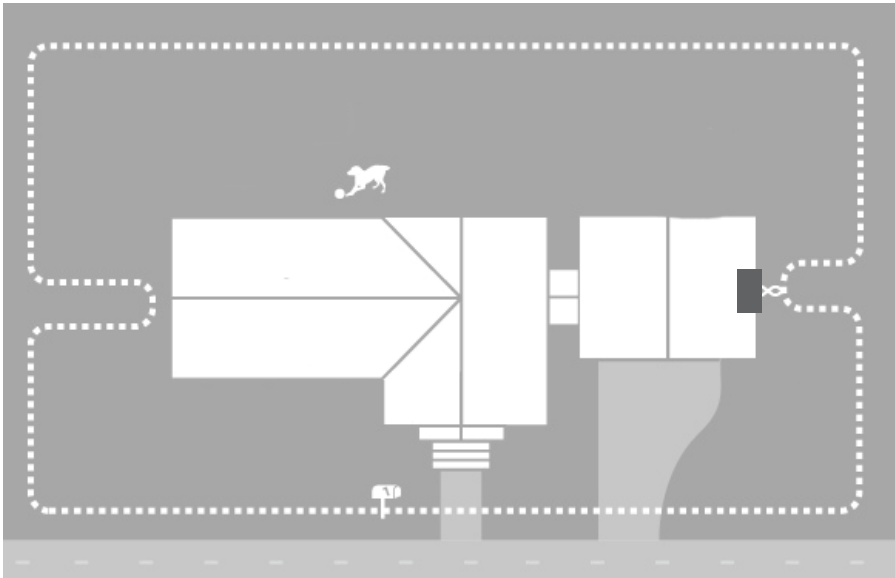

Best for areas that dogs are fenced in the back, but need containment in the front.



- Cable can be attached to a fence, or buried in the ground. If burying, we recommend 50mm minimum depth.
- The T1200 Transmitter is NOT waterproof. The transmitter and AC adaptor must be under cover or protected from water or rain.
- Cable on the sides will need to be **AT LEAST 500mm** apart from each other. Don't assume 500mm is enough. Depending on application, 1 meter may be needed. If not sure...call!
- Cable must be close enough to the house, so the signal can go up to the side of the house. If the cable is too close, or the signal range is too wide, it will activate the collar inside the house. PLEASE verify your work before training your dog.
- If driveway is concrete, try and use an existing expansion joint in the concrete to place your wire. Use a silicon sealer to seal the cable in place.
If asphalt driveway, make a 4mm wide x 5mm deep groove using a circular saw.
Place wire in the groove and use a black silicon sealer to hold in place
If burying in a gravel driveway or under a gate, put the cable through garden hose or PVC pipe to protect it from heavy sources.

Back Yard only

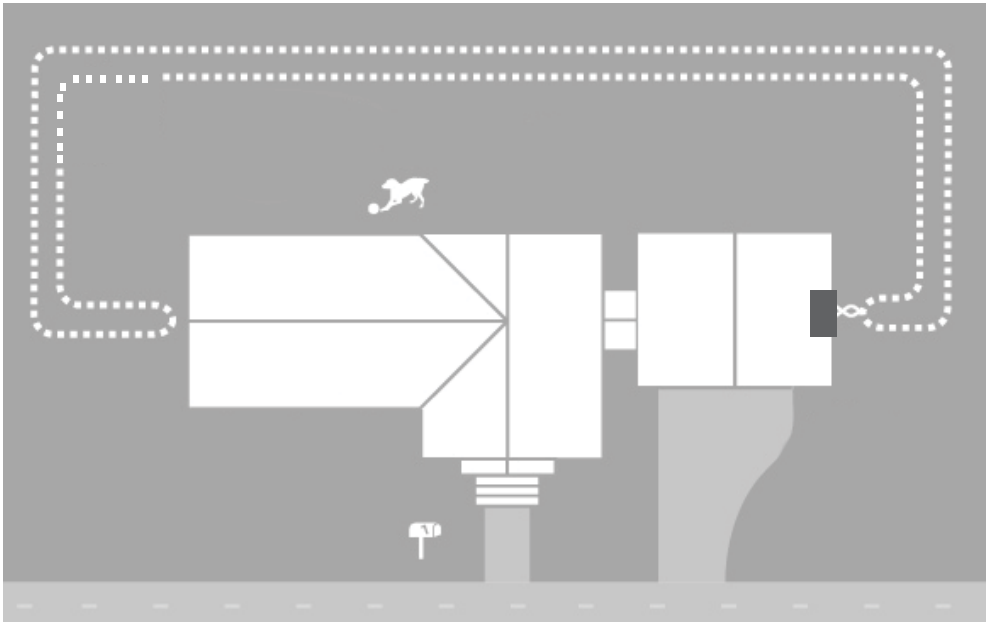

**Popular for suburban applications or canal or water front properties.
This is great for back yards.**



- Cable can be attached to a fence, or buried in the ground. If burying, we recommend 50mm minimum depth. If burying in a gravel driveway or under a gate, put the cable through garden hose or PVC pipe to protect it from heavy sources.
- The T1200 Transmitter is NOT waterproof. The transmitter and AC adaptor must be under cover or protected from water or rain.
- Cable will typically need to be **at least 500mm apart** from each other. If cable is being attached to a fence, wires can be on the top and bottom of the fence. The signal range can be adjusted on the transmitter by using the "Range" dial.
- Cable must be close enough to the house, so the signal can go up to the side of the house. If the cable is too close, or the signal range is too wide, it will activate the collar inside the house. PLEASE verify your work before training your dog.

One-sided system or Canal style block

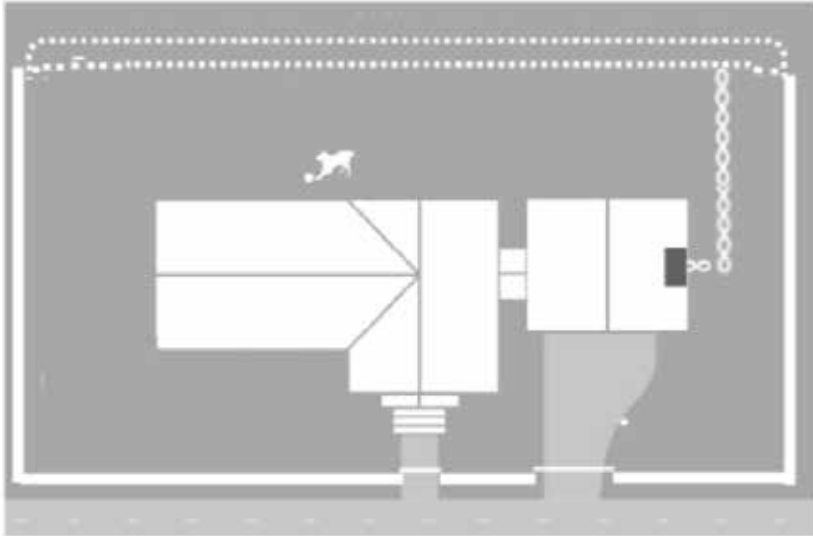

For fenced yards on 3-sides. Can be used best for canals, or frontages.



- Cable can be attached to a fence, or buried in the ground. If burying, we recommend 50mm minimum depth.
- The T1200 Transmitter is NOT waterproof. The transmitter and AC adaptor must be under cover or protected from water or rain.
- Cable will typically need to be **AT LEAST 500mm apart** from each other. If cable is being attached to a fence, wires can be on the top and bottom of the fence. The signal range can be adjusted on the transmitter by using the "Range" dial.

BOUNDARY CABLE QUICK GUIDE



Timber fence.

Use a staple gun to secure to the timber.



In the ground

A spade or pick is best used when burying the cable. Ideally the cable should be at least 50mm deep. 150mm is perfect. When going around corners, try to make smooth curves.

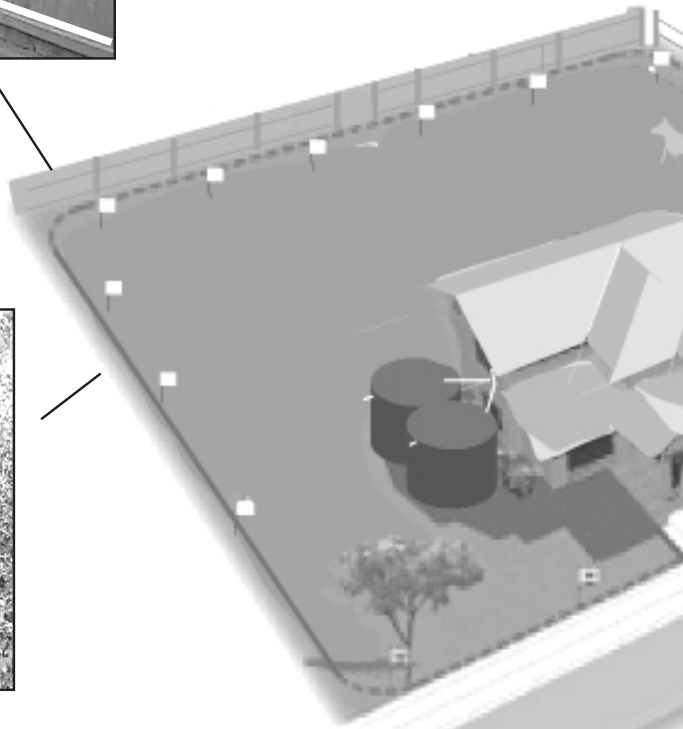

Once your Hidden Fence cable is installed, carefully check to see if it's exactly where you need it. The cable needs to be to properly contain your pet. Remember to address any behavioural issues surrounding your dogs were escaping.

Now begin to program your el

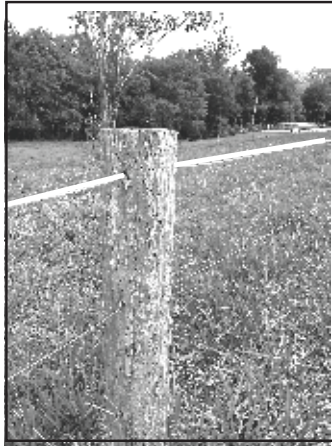

Cattle fence.

String your cable through the pilot holes in the timber posts. You can also use cable ties to secure as well. Position your cable on the fence based on your pets wandering habits. High for jumpers, low for diggers.

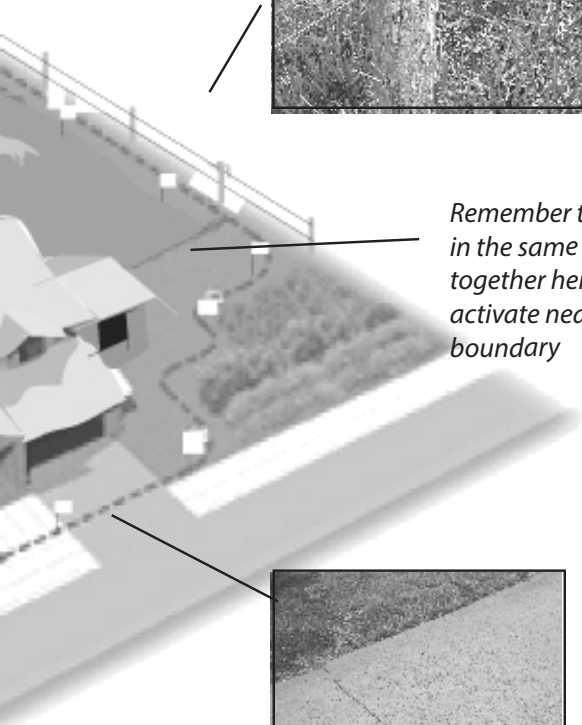

Remember that your cable should be in the same trench, taped or twisted together here so the collar doesn't activate near this connection to the boundary

is installed.
actly where
rly contain
s the
g the reasons



Concrete or Asphalt Driveway.

Use an angle grinder to make a groove in the driveway, or use an existing expansion joint to place the cable in, using a silicon sealant to secure over the cable.

Gravel or Dirt Driveway.

If you have a gravel or dirt driveway, run the cable through a piece of garden hose or pvc irrigation pipe and hand bury about 200mm under the gravel.

electronics.

T1200 TRANSMITTER

The T1200 FM DIGITAL Transmitter is the main controller for the Hidden Fence system. The transmitter sends the FM signal through the boundary cable around the property. The transmitter controls the distance of collar activation from the cable.

FUNCTIONS

1. POWER ON/OFF

Single switch for turning system ON or OFF.

2. RANGE DIAL

The range dial is used to extend or reduce the collar activation zone. GENTLY Turning the dial clockwise will increase the distance of collar activation. Counter clockwise will reduce. This is set at minimum from the factory and must be adjusted by the customer when setting up the fence.

3. AC POWER

Plug for the AC Adaptor power source.

4. EARTH CONNECTOR

Plug for the female connector attached to the green/yellow earth cord.

5. ZIP CORD CONNECTOR

Location for the zip cord connector, which then connects to the 2-Way Connector or Optional surge box.



PROGRAMMING KHZ SWITCHES

These are dealer use ONLY.

If the khz needs to be changed due to a neighbouring system, please contact Hidden Fence or your retailer! DON'T TOUCH



FEATURES



WIRE BREAK ALERT

Pulsing alarm emits from the transmitter if the boundary cable has been severed or a poor connection.



FM DIGITAL SIGNAL

The T1200 transmitter emits a coded FM Digital wave signal through the boundary cable. This specific signal is what the dogs collar receives and activates.

The transmitter should be mounted in a location where the functions can't be subject to tampering.

TRANSMITTER IS NOT WATERPROOF. Transmitter MUST be covered or in waterproof enclosure if mounted outside.

BASIC HIDDEN FENCE INSTALLATION DESIGN

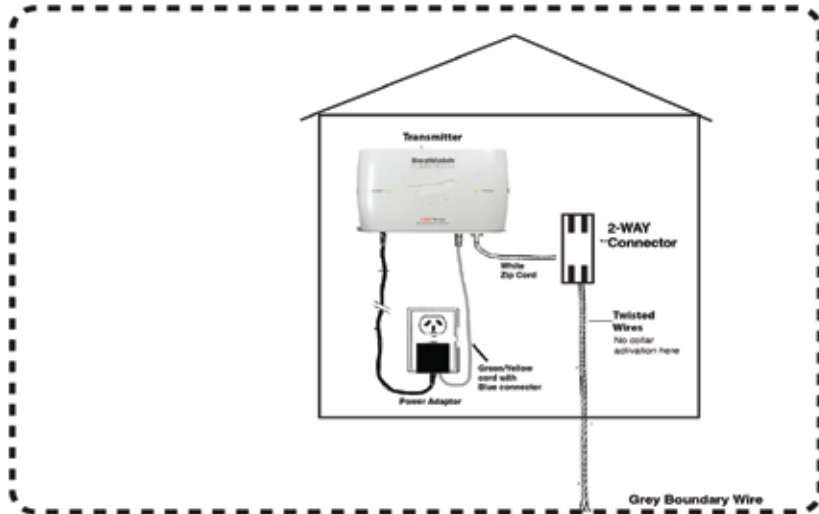

The above image details the basics of the Hidden Fence installation.
Transmitter to 2-way Connector - 2-way Connector to boundary - Boundary wire runs around property



Step 1. Find the best under cover location for the T1200 Transmitter. Typically a garage or car port will suffice. The power source must be a powerpoint that can always remain on with power.

TRANSMITTER MUST BE COVERED and out of the elements. A waterproof enclosure can be purchased separately at <https://hiddenfence.com.au>



Step 2. Mount transmitter using mounting hardware (supplied). Transmitter should be mounted within 300mm from the power point. If mounting using screws, the screws need to be 102mm apart from one another. If not using screws, a strong double-sided tape can be used, as long as it can hold the transmitter properly in place.

Installation

continued...



Step 3. Securely mount your T1200 transmitter using the screws, or the double sided tape option (not supplied).



Step 4. Plug the 18v power supply into a 240v power point and plug the connector into the power port of the transmitter. Once the power is connected, Plug the blue female connector into the male "GND" port of the transmitter.



Step 5. Un-ravel the White Zip Cord, and plug the connector into the "loop" port on your transmitter.



Step 6. Cut a "practical" length off the white zip cord. The length is discretionary depending on your individual installation and requirements. If unsure, leave plenty of length, as you can always cut more later.

Installation

continued...



Step 6. Cut and split the white zip cord. Strip the plastic coating and reveal 1cm of copper. Twist and weave the copper.



Step 7. Flip open all of the red fastener locks in the open position. Take the white zip cord copper ends of the same side of the connector and insert into the open ends of the connector. Lock down each end, and verify they are securely fastened.



Step 8. Now that the white zip cord is secure, it's time to run the boundary cable to perimeter.



Step 9. Strip the plastic coating of the boundary cable and reveal 1cm of copper. Twist and weave the copper.

Installation

continued...



Step 10. Insert the boundary cable inside the connector (either side makes no difference). Once inserted, press and lock down the red fastener. Verify the cable is securely fastened

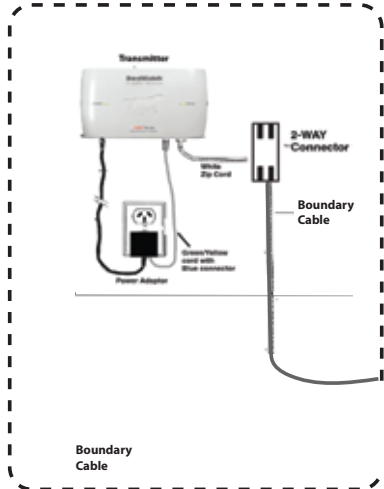

Step 11. Begin installing your boundary using the grey cable. In most cases, the cable runs inconjunction with your perimeter. You can attach to a fence, bury the cable, or both. Once making your way all the way around, return to the connector.

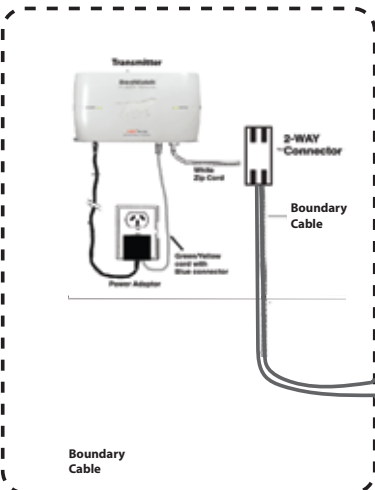

Step 12. On returning to the connector, ensure the cables are close together (or twisted). Doing this will keep the dogs collar from activating near these cables.



Step 13. Once you return to the connector, strip 1cm of the coating off the copper, and insert the copper end into the connector, and lock the red fastener securely.

Installation

continued...

When installing on to fences, be sure to plan accordingly. Ask yourself..."What is my dog doing to escape? Digging? Jumping? Etc.

Chain Link Fence

Cable on Chainlink fence can be woven through, however, using cable ties is more practical.

White line indicates where to position boundary cable



Dogs that jump to escape over fences



Dogs that dig to escape under fences



Dogs that can jump and dig to escape



Bury cable in front of gates and use right angles when positioning to the fence.

Cattle or Stock Fence



Secure cable using cable zip ties

Timber Fence

Cable can be stapled to the timber. Use a staple gun to apply cable to the fence. Be sure NOT to pierce the cable jacket with the staple as this can "earth out" the cable and the receiver won't react to the system.



COLLAR WEARING PROTOCOL

Receiver Collars should be removed from the dog for AT LEAST several hours per day.

DogWatch Hidden Fence recommends that the receiver collar be removed for **at least several hours per day** to ensure no pressure sores (pressure necrosis) will develop on your pets skin.

Pressure sores may develop by having the collar on “too tight, for too long”.

Longer furred pets can have a slightly greater chance of sores developing, especially after swimming or being soaked with water. If sores are evident, remove the collar and wash the skin with a Dettol type of cleanser and allow to dry out and heal.

Pressure Sores, if they occur, can be perceived as “burns”. This is a misdiagnosis, as electronic collars only deliver Transcutaneous electrical nerve stimulation (TENS), which, does not develop heat and is non-injurious.

Pressure sores are very rare, but can happen to 0.5% of pets.

If your dog is a working breed, and is looking after livestock, Please contact us, and we can give advice for using a clock protocol.

RECEIVER COLLAR COMPONENTS

Each Receiver Kit includes critical parts to ensure your receiver will function properly.

Below are the components included in the kit:



RECEIVER



CONTACT POSTS
(Mediums)



COLLAR WASHER



MULTI-TOOL



BATTERY



BATTERY CAP



NYLON COLLAR

RECEIVER COLLAR SET UP INSTRUCTIONS

MEDIUM to LARGE DOGS

OPERATING INSTRUCTIONS

Scan the QR Code for Instructions



R9 Receiver Collar

Manufactured by DogWatch, inc.

SMALL DOGS

OPERATING INSTRUCTIONS

Scan the QR Code for Instructions



M7 Receiver Collar

Manufactured by DogWatch, inc.

HIDDEN FENCE TRAINING PROTOCOL

By now, your Hidden Fence should be completely installed, receiver collar assembled, and all of the settings should be in accordance with best user practices!

Comfort/ Discomfort optioning when training with the hidden fence is the cornerstone of the success when containing pets safely while preserving welfare principles. DO NOT rush the introduction of your pet to the hidden Fence. All dogs learn at different paces.

Training Snapshot

Focus on 4 principles to help the dogs understanding of its new boundaries:

- 1- Identification the new boundary (audible and visual)
- 2- Recognition that the (audible/ visual targets) are unfavourable.
- 3- Redirection or Retreat when encountering the boundary (relief)
- 4- Exposure and Emphasis on play within the boundary

Train your dog using the 90/10 principle. 90 percent positive experience, and 10 percent aversive exposure. With this principle, the dog will learn with clarity where it “can and cannot” go on the property, all while maintaining a positive outcome.

TRAINING PHASE 1

Audible and Visual association
(use of receiver collar and training flags)

Recognition and Redirection
(low level or subtle Electrical Stimulation)

TRAINING PHASE 2



**Risk versus Reward (choice pointing),
Prey Drive Elicitation**
(assess and likely raise stimulation level)

READY TO START?? Go to next page!!

HIDDEN FENCE TRAINING PROTOCOL

Before you Begin...some Fundamentals of Training

Avoid using voice commands and/or using food treats as reward during each session

1. **Avoid** using vocal commands during the training for a Hidden Fence. Voice commands are too often associated with something related to the owner and can interrupt key focuses. Hidden Fences work best when a more “anonymous” application is presented. 
2. **Avoid** Food treats (administered) to the dog during a Hidden Fence training session often preoccupies the dog and compromises the focus needed to properly condition the dog without the wrong association. The application of an aversive or consequence needs to be delivered with the highest regard for timing and association. 

Flat Collars or Harnesses are recommended when using the lead.

Due to the gentle but quick redirection required to develop a sense of urgency, halter collars are not recommended as they have the potential for injuring the dog's neck if jerked by accident. Choke collars are not recommended, as this would add a secondary correction and confuse the dog about which is the source of consequence.

Several objectives are present during the conditioning.

The dog needs to understand key elements; if signs of recognition aren't present after a few sessions, contact Hidden Fence and changes may be suggested so the dog receives clear understanding of the hidden fence.

The pet must be on lead at all times when outside until the next session. This maintains control of the dog's movements so there are no inconsistencies. Longer lead length is preferred. However, if the owner feels as though that they have control of the situation and can manage their dog without placing the dog in critical situations, the dog may be taken off lead for organic exposure to the hidden fence while supervised, but the owner does this at their own risk.

A typical schedule for the owner to follow to reinforce the training is about twice a day for roughly ten minutes each session. Most of the ten minutes is walking about the property and creating a positive atmosphere for the dog, i.e.: playing, running, sniffing, etc. Typically only around 2 to 3 minutes are used for the boundary training; the rest of the time is spent playing.

The Hidden fence receiver is programmed so it's only on the lowest ES level that only causes a slight body language response, not a vocalised response. This allows the dog to be signalled at the flags, but subtle or low aversive is given, as the dog wouldn't understand why it received a sharp stimulation or correction.

Keep pet “on lead” and/or supervised until properly trained.

As the pet's owner, you are always responsible for your pet's actions and behaviour

HIDDEN FENCE TRAINING PROTOCOL

1

Flag Placement

Hidden fence training flags are always recommended when introducing your pet to the hidden fence. These are supplied when purchasing the kit. Your pet's training and understanding of the fence rely on using the flags. Not using the flags can severely compromise good containment.

Once the desired collar activation distance is set (via the transmitter), and you're ready to introduce the dog to the fence, you can now begin putting the training flags in position.

Your dog should NOT be present, when the flags are being placed.

Now Begin:

1. Training flags are almost always placed 500mm just inside the signal edge where the collar will begin to "beep" the audible tone.
2. Flags are spaced approx. 1.5 metres apart. Flags may be even closer depending on the application. The flags operate as a visual cue as to where the signal edge is revealed.

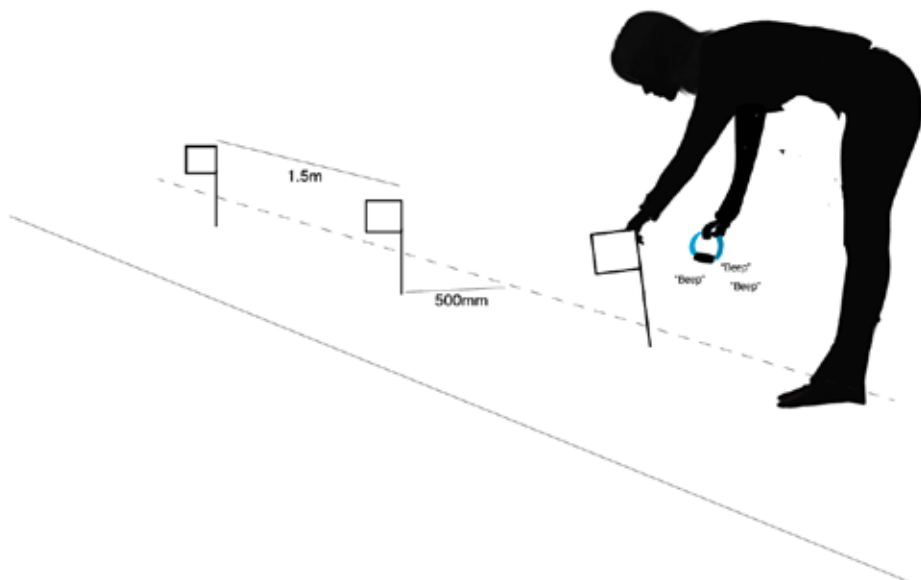

HIDDEN FENCE TRAINING PROTOCOL

2

FITTING THE COLLAR TO YOUR DOG

- ① While your dog is in the "standing" position, put the collar around his neck, and ensure that you buckle the collar behind his ears, and that the collar is positioned high on his neck area.
- ② Gently move the receiver back and forth to verify you have successfully allowed the contact posts work through the fur.
- ③ While in the standing position, the receiver contact posts should fit "snugly" and each contact should be through the fur and touching the skin.
- ④ Many times the receiver will sit slightly to the side of the neck. It frequently moves to around the 4 or 8 o'clock position on the dogs neck. This is ok as long as the contact posts are making contact.

The receiver often does not stay in the same location on the dogs neck. It will move around and sit to either side from time to time. This is normal, however remember that both contact posts must touch the skin to issue the stimulation; if only one contact touches the skin, no stimulation will be delivered..



The Receiver Collar Must be removed once a day.

All collars, including electronic collars can cause irritation or sores from being worn for too long. A condition called pressure necrosis can develop when a collar is too tight, worn for too long, or both. It's the owners responsibility to ensure the collar fit is checked regularly, and is periodically removed to prevent sores..

HIDDEN FENCE TRAINING PROTOCOL

3

Training Phase 1

Audio Visual Association

Ideally, the first technique benefits by using two people.

DOG ON LEAD

1

Person 1, holds the lead and keeps the dog approximately 1.5 metres inside the flags.

Person 1 does nothing but hold the dog in place; no talking or getting the dogs attention.



2

Person 2 steps into the signal field and holds the collar down near a flag so the receiver is emitting the audible tone. While the tone is activated, **person 2** shakes the flag with medium urgency. Once the dog appears to target the flag, **Person 2** moves down the line and allows the collar to beep at several flags while shaking.



3

Both participants then move to various other spots in the yard and repeat the technique. This allows the dog to recognize consistency.

No verbal commands are used during this process.

The dog needs to focus on the audio/ visual signals without distraction.

If the owner or whomever interrupts the process with speaking to the dog, the dog will remove its attention away from the flags and tone and may associate the person holding the collar as part of the process.



The audio visual technique should be applied at different areas around the boundary until the dog becomes somewhat suspect of the audible tone and flags, and begin to show signs of apprehension.

HIDDEN FENCE TRAINING PROTOCOL

4

Training Phase 1

DOG ON LEAD

Recognition and Redirection

4

Now set your dogs receiver collar to level 1 using the multi-tool, and place the collar on the dog according to the instructions.

After a quick run around the safe zone of the interior of the property, the owner brings the dog back to the original spot where the dog first heard the warning tone near the flags. The owner then allows THE DOG to make an approach to the boundary on its own initiative. (DO NOT drag or force the dog to experience the stimulation)

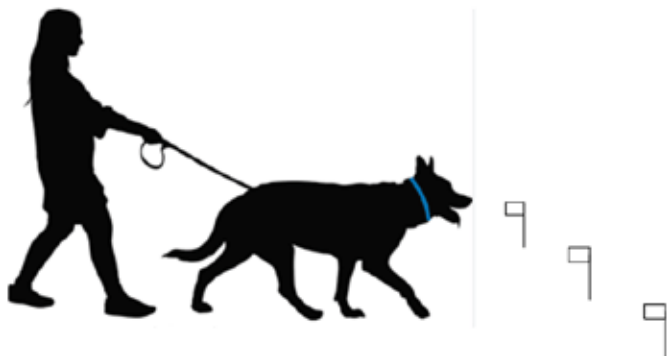

5

Once the dog approaches, and gets within proximity with the flags, the audible "beep" from the receiver collar will start. Typically the dog will tilt its head in curiosity. If the dog is a bit keen to go in further, it will feel the level 1 stimulation from the receiver.

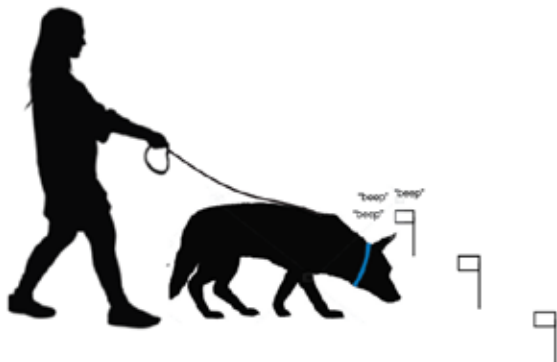

HIDDEN FENCE TRAINING PROTOCOL

4

Training Phase

DOG ON LEAD

Recognition and Redirection

6

Once the dog feels the stimulation, the best reaction is a noticeable sign of recognition by the dog via body language...such as a slight jump back without a vocal response.



Many times the dog will show little to no response. If so, step back, then see if the dog is willing to approach again. Monitor the dog's response, and if it shows little care or response, then walk the dog back away from the flags, check and verify the fit of the collar, and cautiously raise the stimulation training level to the next level.

(Do not raise the level of stimulation to more than one level at a time. Attempting to rush the training by going too high of a stimulation is not recommended and will likely regress the result)

If the dog is receiving the stimulation, but appears to "freeze" and not know what to do, the owner may then give a very quick, but gentle "tug" of the lead; or a slightly urgent redirection. A redirection or retreat should only be approximately 2 metres from the flags.

(It's important to note that the "tug" and "redirection" is not meant to be a correction. It's meant to stop the dog from going further after receiving correction near the flags, and finish the process by retreating backwards.)

It's better if the dog chooses to gain relief by backing away on its own initiative.

This technique is to be performed at different parts of the boundary for just a few minutes. DO NOT OVER DO IT!

Allow the dog to show signs of recognition and mild apprehension. Not fear, but respect!

Perform this technique for "up to" 3 days, if needed!

If the progress is satisfactory, advance to Testing Phase; if the progress is not satisfactory, more "exposure" is given, with a possible change in technique.

HIDDEN FENCE TRAINING PROTOCOL

5

Testing Phase

Risk versus Reward

(Choice Pointing)

10

If the dog attempts to approach the flags to get the "bone" and jumps back after receiving the stimulation, This is a great result; However, do not reward the dog. Simply walk over the flags, shake a few of them so the dog sees them, then retrieve the "bone" and possibly try again in another spot to verify his understanding is consistent.

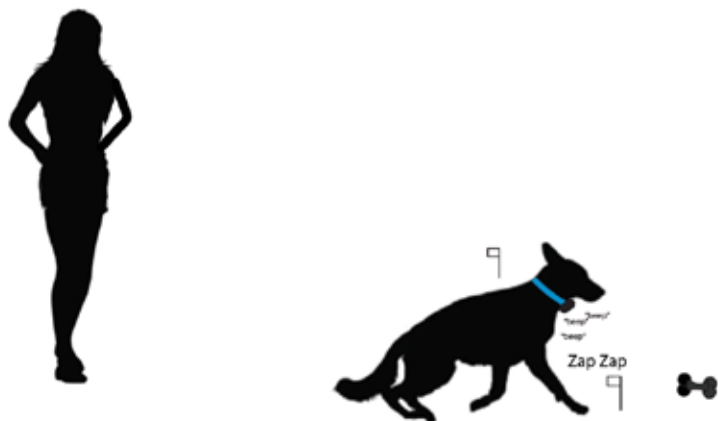

If the dog displayed no reaction and retrieved the "bone", guide him back to the center of the yard and check the fit of the receiver collar and verify the contact posts are touching his skin, if the collar fit is correct, then try again, but possibly raise the stimulation level.

If the dog makes it through the stimulation zone and ends up on the other side of the hidden fence, do not call him. Simply walk over to him, remove his receiver collar and walk him back through to the yard.

Try lesson again, but verifying the fit and stimulation level.

On many occasions, a friend's dog is used on the opposite side of the boundary fence, yet far enough away so that it's not in the proximity of where the dog will receive its first stimulation. The reasons for this is we don't want the dog on the containment system to associate the dog on the opposite side of the fence with the aversive stimulation.

HIDDEN FENCE TRAINING PROTOCOL

5

Testing Phase

Risk versus Reward

(Choice Pointing)

- 7** Testing Phase (Risk v Reward) is provoking the dog to challenge the Hidden Fence with a high value choice to see if he feels it's worth the risk of receiving the aversive stimulation. This usually starts 1 to 3 days after the Training phase has proven to be successful, and when the dog understands his boundaries by showing apprehension to the flags and tone.

At this stage, you may need to raise the training level that is sufficient to create a larger "aversive" effect by the dog once it enters the boundary. This is suggestion only. If the dog responds well to the training level used in Phase 1, then you may leave it and observe the dogs responses.

- 8** Set up a series of events that are designed to tempt or distract the dog to go past the flags. This can be relatively easy or difficult depending on the dog's prior motivations or escaping habits. An easy distraction can be something of "high value", like a bone or food that the dog normally doesn't receive as a regular treat.

The dog may be able to be "off lead" as this stage AS LONG as the dog is SUPERVISED and you feel you have control of the process.

- 9** During this test, walk the dog around the yard a bit to let him have a sniff and do normal "dog things". Once he's ready, take the "bone" and toss it in the stimulation zone, just over the flag position.

Watch to see if the dog attempts to investigate.

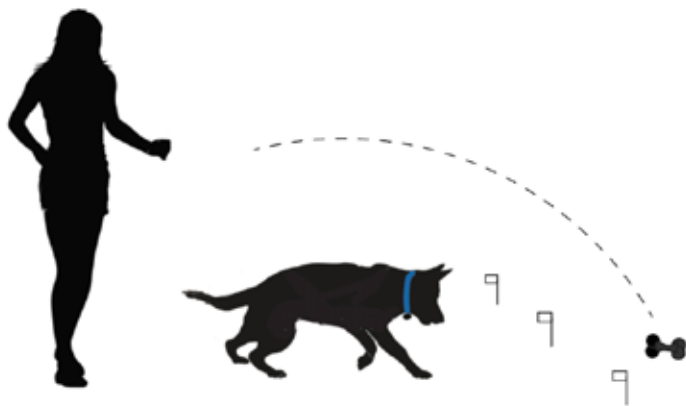

HIDDEN FENCE TRAINING PROTOCOL

6

Play Phase

Play and Reinforce

- 11** At this point, if the dog is showing obvious signs of respect and awareness of the flags, and appears to comfortably avoid them, yet still walk or run around the yard, then your dog is on track to adapting to his new boundary.

Frequent tests and challenges for him is recommended in the early stages of your dog on the hidden fence system. We usually see a dog at around 90% adapted after just a few days; However, it can be a couple of weeks of reinforcement to feel comfortable that your dog will stay in, even with high value temptations on the other side.

It's very important to make sure your dog has "chosen" the comfort option and stay in before leaving unsupervised.

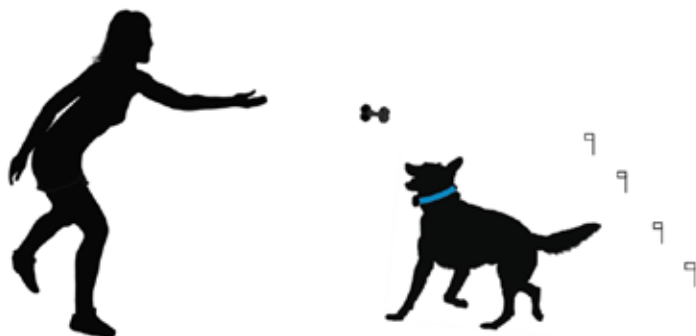

Reinforce the balance of the "comfort/ discomfort" areas by offering a lot of positive play in the yard, by doing frequent activities that are exciting for the dog.

Playing ball, hide and seek, etc are great ways to ensure the dog that the "yard" is the best place to be, and safe!!!

YOU'RE DONE!!!!

Well...almost. Please remember that each containment situation and dog is different. You are encouraged to contact Hidden Fence for advice if you're unsure of the training results.

The Receiver Collar Must be removed once a day.

All collars, including electronic collars can cause irritation or sores from being worn for too long. A condition called pressure necrosis can develop when a collar is too tight, worn for too long, or both. It's the owners responsibility to ensure the collar fit is checked regularly, and is periodically removed to prevent sores.

Flags can be removed after 1 month of reliable containment.

After the 1 month, remove every 4th flag per week until they have all been removed.

Collar Receiver does not appear to be activating at the boundary

- Check that the battery was inserted correctly in the battery compartment, **and** the battery cap is in the lock position.
- Check the mounted transmitter control box that all LED's are on and **the signal field is set correctly on the range dial located on the side of the transmitter.**

The Collar Receiver doesn't seem to work unless right next to the cable.

- **Check the range dial** on the side of the transmitter controller for the correct distance.
- Replace the collar battery with approved battery. SAFT LS14250 3.6v
- Check the boundary cable to ensure it hasn't been crushed, or the outer casing of the cable hasn't been stripped and the copper wire inside isn't touching something wet or metal.
- If using a dual loop design, make sure that the wires are **AT LEAST 300mm apart.**

The Collar Receiver activates inside the house near metal doors, etc.

- Check to see if your cable is running parallel too close to the home, or running too long in-conjunction with metal objects close to the house. Running parallel with concrete driveways for too long a distance can do this as well.
- Check your distance on the range dial. If you have it too wide a signal, it could be flooding the area with signal.
If the problem persists....contact a Hidden Fence Dealer for a service call.

The transmitter is making a loud beeping sound.

- If the mounted transmitter is giving off a loud "beeping" sound, it's typically a wire break. Wire breaks can be difficult to find at times, however, it's almost always where the ground has been disturbed. Digging, planting, or driving over with machinery are usual suspects.
- Travel along the cable to see if there is any disturbance. If so, splice in a new piece and check to see if the beeping stops.

My dog does not appear to be receiving the stimulation.

- Make sure the **collar is fit properly.** If only one contact is touching the dogs skin, and the other is not...your dog WON'T feel the stimulation.
- Make sure the stimulation is set to a level that the dog respects.
- Make sure your distance is set properly.

I seem to have "less" distance signal at the concrete driveway.

- If there is a considerable amount of "reo" in the concrete, it can reduce the signal to almost half. In many cases this is normal.

I've turned everything on, and I'm not getting signal at the wire, but all my lights are on on the electronics.

- Check your range dial for distance. If you haven't yet adjusted the range, this could be it.
- Check to see if your cable is "earthed" out on the boundary. It could be stripped and touching or crushed against something metal or near heavy moisture.

If this page was unable to solve your issue, please contact your supplier or contact a Hidden Fence Professional for assistance. There will be a charge if the Hidden Fence Dealer needs to appear on-site.

DogWatch, DogWatch logos, Performance Series, and SafeLink are registered trademarks of DogWatch Inc.

DogWatch products are protected under U.S. Patent numbers:
5,353,744; 5,465,687; 6,079,367; 6,360,698; 6,467,435; 6,575,120; 6,825,768 and D,491,481.

This device complies with part 15 of the FCC Rules. Operation is subject to the following two conditions: (1) This device may not cause harmful interference, and (2) this device must accept any interference received, including interference that may cause undesired operation.

DogWatch products are lead-free and compliant with the Reduction of Hazardous Substances (RoHS) initiative.

©2019 DogWatch Inc. All rights reserved. 295025 Rev. G 11-2013



All DogWatch and Hidden Fence brand products comply with ECMA (Electronic Collars Manufacturers Association) and ACMA (Australian Communications and Media Authority)

Hidden Fence brand® should not be confused with Invisible Fence® or Invisible Fencing® which are products and registered trademarks of Invisible Fence, Inc. sold in the US.

© 2000-2019 DogWatch Inc. All rights reserved. No photographs, illustrations or text can be reproduced in any form without the express written consent of DogWatch Inc. Dog Fence.

© 2002-2019 Hidden Fence. All rights reserved. No photographs, illustrations or text can be reproduced in any form without the express written consent of Canine Containment Company

Pty Ltd. DogWatch, DogWatch logos, FastReact™, Automemory™, Safelink™, Performance™, Scoot™, PowerPak™, Pet-Friendly™, are all registered trademarks of DogWatch, inc. Dog Fence.

© 2002-2019 "Hidden Fence brand –experts in pet containment...guaranteed" is a registered logo trademark.

© 2010-2019 Dog Stop by Hidden Fence brand is a registered logo trademark of Hidden fence brand.

© 2002-2019 Canine Containment Company Pty Ltd. All rights reserved. DogWatch Hidden Fence Systems, The Hidden Fence Company and The Hidden Fence Company logos are all Registered trademarks of the Canine Containment Company Pty Ltd.



Hidden Fence®

ACN: 101 419 149



Hidden Fences

www.hiddenfence.com.au